

#BECLEVER



# TRANSMISSION FILTER KITS

OUR SMART EXPERT KITS+

FOR A SMOOTH CHANGE



PREMIER  
TecDoc®  
DATA SUPPLIER

Powered by **VIERÖL**

[www.vaico.de](http://www.vaico.de)



# VAICO

ENGINE & TRANSMISSION PARTS  
BY VIEROL

The VAICO quality brand stands for high-quality automotive parts. Our focus is therefore on the heart of the car: the engine and the transmission.

As a specialist in the independent parts market, and one that is known worldwide, we offer an extensive range of products, from suction modules to venting hoses and cylinder head covers. We cover more than 13,000 different vehicle models.

Our VAICO parts even cover 95 per cent of the German vehicle market. Whether transmission filters and sets, oil pans, or housing – VAICO offers the best quality products. Suitable transmission oil is also available, in addition to engine oil, antifreeze or additives.

Our range has been bolstered by innovative repair sets from the Expert Kits+ selection. These kits include sets for changing oil, repair kits with hoses and venting valves or transverse control sets. The Q+ seal identifies parts with OEM quality, just like those made by the original equipment manufacturers.

Our competent expert team works everyday to optimise our VAICO automotive parts and to extend our range. Our aim is to have satisfied customers all around the world.

## TRANSMISSION FILTER KITS

The best transmission oil is eventually “exhausted” in terms of performance. The result: there is increased material wear inside the gearbox. Even so-called “Lifetime Oils” are not exempt from this problem. In order to prevent damage to the transmission and its control unit, we advise changing gearbox oil and replacing the filter set at regular intervals. Depending on the vehicle, this is within a period of five to six years or 60,000 to 100,000 kilometres mileage.

The performance of the transmission can be significantly improved by changing the oil, cleaning or flushing the control unit and replacing the hydraulic filter: It shifts noticeably smoother, faster and cleaner again.

With more than 700 different hydraulic filters and hydraulic filter sets – tested according to German quality standards – the VAICO quality brand offers an extensive product programme. A matching ATF range „Made in Germany” is also available.

VAICO offers a comprehensive range of automatic transmission components with over 700 products for more than 10,000 vehicle models. This means that 95 % of vehicles on the German market can be covered.

Especially with complete solutions in the „EXPERT KITS+” category, VAICO supplies a comprehensive oil change kit including all necessary components such as the appropriate oil quantity, oil pan with spin-on filter, gasket, oil drain plug and matching screw set and plug-in housing. The spin-on filter system for plastic transmission oil pans enables the individual transmission filter to be replaced at low cost.

The lubricants contained in the oil change kit are MADE IN GERMANY and offer perfect protection for the engine and transmission. Initial raffinates and a customised innovative additive guarantee compliance with today’s practical requirements. VAICO products are characterised by very good lubricating properties at high and low temperatures, as well as extreme wear protection under all operating conditions.





# LUBRICANTS

**WITH MANUFACTURER APPROVAL**



The VAICO quality brand supplies chemical materials in accordance with the original approvals and selected products with original manufacturer approvals\*\* and offers good value and high quality alternatives to OEM products for all common European brands

\*\* Applies only to selected oils.

## EXPERT KITS+ XXL

Automatic transmission flushing with more oil

### Example V30-4427-XXL consists of:

Suitable quantity of transmission oil

incl. additional oil  
for a flush



Guide and fill  
level tube

Filling  
adapter

Drain plug

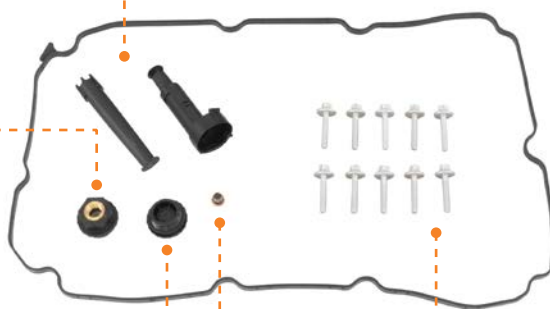

Converter  
drain plug

Oil pan  
screws



Oil pan incl.  
filter and seal

### TRANSMISSION FILTER KITS IN AN ENVIRONMENTALLY FRIENDLY COMBINATION!

VAICO transmission oil change kits are not only developed for first-class performance, but also with a clear focus on efficiency and sustainability. By reducing the number of oil containers, less plastic waste is produced, which not only protects the environment, but also saves even more time during handling.

In addition, the oil containers are made from recycled material, which further minimises the use of plastic.



## EXPERT KITS+

Automatic transmission oil change

### Example V30-4427 consists of:

With oil pan gasket, screws, sealing ring, oil quantity for standard oil change and accessories

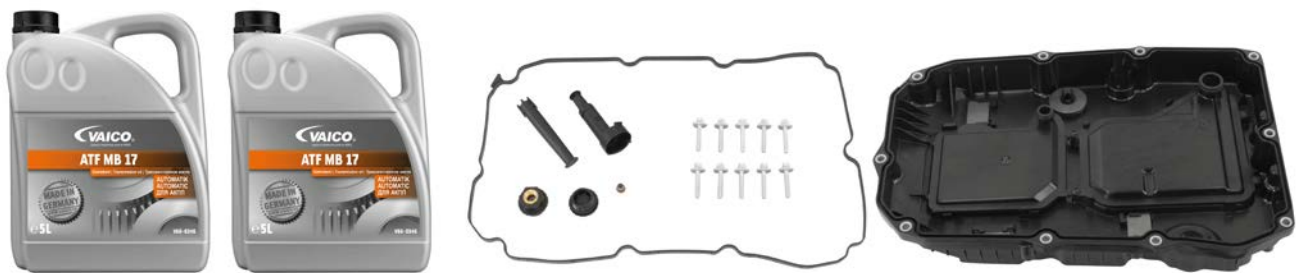

## EXPERT KITS+ BEK

Kit version without oil (e.g. if already available in bulk containers in the workshop)

### Example V30-4427-BEK consists of:

With oil pan gasket, screws, sealing ring and accessories





## EXPERT KITS+ SP

Kit version with „special“ requirement (with less oil for vehicles without torque converter drain plug)

### Example V30-2254-SP consists of:

with sealing ring, seal, oil quantity for standard oil change and accessories



MANY OF OUR ARTICLES ARE AVAILABLE

AS -BEK, -XXL OR -SP KITS.

You can find the complete range at [www.vierol-shop.de](http://www.vierol-shop.de)

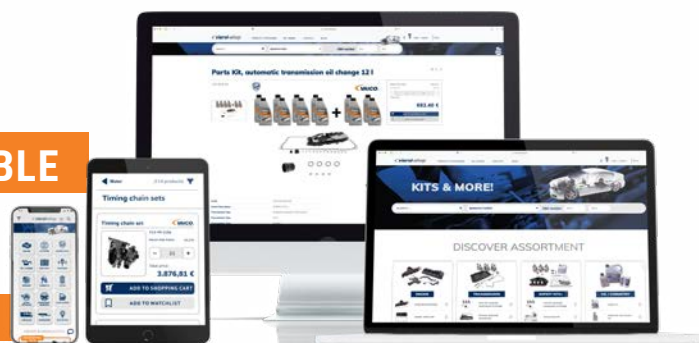



**STRONGER TOGETHER**

**WE'VE GOT YOU COVERED**

- › TRANSMISSION FILTER KITS
- › ALL IN ONE BOX
- › PERFECTLY COMBINED

**WWW.VAICO.DE/ZUSAMMENSTARK**





## SELECTION FROM THE RANGE

# TRANSMISSION FILTER KITS

Brand	Article No.	X-Ref*	Anwendungen	Transmission
	V10-3025	02E 398 051 kit	A3, Golf V-VII, Passat	6-speed DSG® (DQ250)
	V10-3213	01V 325 429 kit 2	A4, A6, A8	5-speed (5HP19)
	V10-3214	09D 325 435 kit2	Touareg, Q7	6-speed (09D) - Aisin Warner TR60SN
	V10-3215	09K 325 429 kit1	T5	6-speed (09K) - Aisin Warner TF60SN
	V10-3216	0B6 325 429 kit2	A4, A5, Q5	6-speed (6HP28)
	V10-3217	09G 325 429 A kit2	Altea, Leon, Toledo	6-speed (09G) - Aisin Warner TF60SN
	V10-3218	09G 325 429 kit2	A3, New Beetle, TT	6-speed (09G) - Aisin Warner TF60SN
	V10-3219	0AT 325 429 kit2	Q7	6-speed (6HP19)
	V10-3220	0B5 325 330 A kit	A4, A6, A7, A8, Q5	7-speed S-Tronic (DSG®)
	V10-3221	09M 325 429 kit2	Passat, Tiguan	6-speed (09M) - Aisin Warner AQ450
	V10-3222	0C8 325 435 kit2	Touareg, Q7	8-speed (0C8) - Aisin Warner
	V10-3223	0BH 325 183 B kit	Q3, RS3, T5, TT	7-speed DSG® (DQ500)
	V10-3224	0BW 398 009 kit	A6, A8, Q5	8-speed (8P55FLH)
	V10-3225	0BK 398 009 A kit	A4, A5, A6, A7, Q5	8-speed (8HP55)
	V10-3226	09L 325 429 kit3	A4, A6, A8, Phaeton	6-speed (6HP19)
	V10-3227	09L 325 429 kit4	A4, A6, A8, Phaeton	6-speed (6HP19)
	V10-3228	01L 325 429 B kit1	A6, A8	5-speed (5HP24)
	V10-3229	09E 325 429 kit3	A6, A8, Phaeton	6-speed (6HP26)
	V10-3230	09E 325 429 kit4	A6, A8	6-speed (6HP26)
	V10-3231	0AW 301 516 H kit	A4, A5, A6, A7	continuously variable CVT (0AW)
V10-3292	09L 325 429 kit5	A4, A6, A8, Phaeton	6-speed (6HP19)	
V10-3293	09L 325 429 kit6	A4, A6, A8, Phaeton	6-speed (6HP19)	
V10-3847	01M 325 429 kit	A3, Golf III & IV	4-speed (01M)	

\* For detailed vehicle information, please refer to the vehicle lists under [www.vierol-shop.de](http://www.vierol-shop.de).

Notes: Temporary offers are only valid while stocks last. All offers remain subject to prior sale. Our general terms and conditions of sale and delivery as well as our warranty conditions apply, which are available for download on our website. All prices are net prices. Errors excepted. Reference numbers and names, with the exception of VIEROL AG, are for comparison only and may not be disclosed in invoices. They are non-binding and no indication of origin. © VIEROL AG

Brand	Article No.	X-Ref*	Applications	Transmission
	V10-4991	0GC 325 183 kit2	A3, Golf VII, Leon, Q2	7-speed DSG® (DQ381, DQ500)
	V10-5390	OCK 325 421 A kit2	A4, A5, A6, A7, Q5	7-speed S-Tronic (DL382)
	V10-5540	G 052 180 A2 kit	A4, A6, A8, Exeo	continuously variable CVT (01J)
	V10-5541	OD5 398 009 C kit	A4, A5, A8, Q5, Q7	8-speed (0D5, 8HP65A)
	V10-5546	OCM 301 519 kit1	Amarok	8-speed (AL450)
	V10-5582	OAM 325 433 E kit	A3, Golf VII, Passat	7-speed DSG® (DQ200)
	V10-5612	09P 325 429 kit2	Arteon, Q3, Tiguan	8-speed (09P / AQ450)
	V10-7344	09Q 325 429 kit2	Crafter	8-speed (09Q / AQ450)
	V10-7674	G 052 527 A2 kit	eGolf, e-up!, ID 3, ID 4	Reduction gearbox VA
	V10-8007	OD5 398 009 B kit1	A4, A5, A6, A7, A8, Q5	8-speed (0D5, 0D7)
		V20-2081	24 11 7 543 550 kit2	E53, E65, E83
V20-2082		24 34 1 422 513 kit	E32, E34	5-speed (5HP18 - A5S310Z)
V20-2083		24 34 1 422 419 kit	E31, E32, E34	5-speed (5HP30 - A5S560Z)
V20-2084		24 11 7 557 070 kit	E46, X3, Z3	5-speed (GM5L40E - A5S360R/390R)
V20-2085		24 34 1 423 376 kit	E38, E39, E46, Z4	5-speed (5HP19 - A5S325Z)
V20-2086		24 34 1 422 673 kit2	E31, E38, E39	5-speed (5HP24 - A5S440Z)
V20-2087		24 11 7 557 069 kit	X5	5-speed (GM5L40E - A5S360R/390R)
V20-2088		24 15 2 333 903 kit	E60, E90, E65, F01	6-speed (6HP26Z)
V20-2089		24 15 2 333 907 kit	E87, E90/91, E60/61	6-speed (6HP19Z)
V20-2090		24 11 5 A13 115 kit	F10/11, F20, F30, X1, X3	8-speed (8HP70Z / 45Z)
V20-2092		24 11 7 593 565 kit2	E81, 82, 87, 88, 90	6-speed (GM6L45)
V20-2093		24 15 2 333 825 kit	E46, E39, X3	5-speed (GM5L40E - A5S360R/390R)
V20-2742		28 10 7 842 828 kit2	E82, 88, 89, 90, 92, 93	7-speed DCT (GS7D36SG)

\* For detailed vehicle information, please refer to the vehicle lists under [www.vierol-shop.de](http://www.vierol-shop.de).

Notes: Temporary offers are only valid while stocks last. All offers remain subject to prior sale. Our general terms and conditions of sale and delivery as well as our warranty conditions apply, which are available for download on our web-site. All prices are net prices. Errors excepted. Reference numbers and names, with the exception of VIEROL AG, are for comparison only and may not be disclosed in invoices. They are non-binding and no indication of origin. © VIEROL AG





## SELECTION FROM THE RANGE

# TRANSMISSION FILTER KITS

Brand	Article No.	X-Ref*	Applications	Transmission
	V20-4061	24 11 8 632 189 kit1	F30, G11, G20, G30	8-speed, Hybrid (8HP75HZ)
	V20-4186	83 22 2 355 599 kit1	F45/46, F39, F48, I8	6-/8-speed (GA6F21AW / GA8F22AW)
	V20-4300	83 22 2 433 157 kit1	F39, F40, F45/46, F48	7-speed DSG® (7DCT300)
	V20-4670	83 22 2 413 477 kit1	F45/46, F48, V90, XC60, C4	8-speed (GA8G45AW)
	V51-0650	24236933 kit2	Silverado, Tahoe, Escalade	6-speed (GM 6L80)
	V33-0525	K05015267AD kit2	Cherokee, Ram	5-speed (45RFE, 55RFE)
	V33-0533	K68218925AB kit1	200, Ducato, Voyager	9-speed (ZF9HP, 948TE)
CITROËN	V22-0737	2263.33 kit1	C3, C5, 207, 306	4-speed (AL4)
	V25-0796	1 589 089 kit	Focus, Mondeo IV	6-speed Powershift (6DCT450)
	V25-0797	5 046 305 kit2	Fista VI, Focus I	4-speed (4F27E, FN4A-EL)
	V25-2191	5 275 555 kit2	Mustang, F-15D590	6-speed (6R80)
	V25-2253	2 335 955 kit2	F-150, Mustang, Ranger	10-speed (10R80)
HYUNDAI	V52-0389	46321-23001 kit2	Accent, Elantra, i30	4-speed (F4A42, A4CF1/2)
	V52-0470	46321-3B000 kit2	iX35, Santa Fé, Tucson	6-speed (A6LF1/2/3)
MAZDA	V32-0194	FZ01-21-500 kit2	3, 6, CX-5	6-speed (Jatco FW6A-EL)
	V30-2252	A 169 377 13 95 kit3	W169, 245	Continuously variable CVT (722.8)
	V30-2253	A 169 377 13 95 kit4	W169, 245	Continuously variable CVT (722.8)
	V30-2254	A 140 277 00 95 kit3	W202, 203, 204, 211, 212	5-speed (722.6)
	V30-2255	A 168 377 03 95 kit	W168	5-speed (722.7)
	V30-2256	A 222 277 20 00 kit2	C209, W203, W211	7-speed / 7G-Tronic Plus (722.9)
	V30-2257	A 246 377 24 00 kit1	C117, W176, W246	7-speed DCT (724.0)
	V30-2258	A 221 277 02 00 kit2	C209, W203, W211	7-speed / 7G-Tronic (722.9)
	V30-2377	A 725 270 37 07 kit1	W205, 212, 213, 222	9-speed (9G-Tronic 725.0)

\* For detailed vehicle information, please refer to the vehicle lists under [www.vierol-shop.de](http://www.vierol-shop.de).

Notes: Temporary offers are only valid while stocks last. All offers remain subject to prior sale. Our general terms and conditions of sale and delivery as well as our warranty conditions apply, which are available for download on our website. All prices are net prices. Errors excepted. Reference numbers and names, with the exception of VIEROL AG, are for comparison only and may not be disclosed in invoices. They are non-binding and no indication of origin. © VIEROL AG

Brand	Article No.	X-Ref*	Applications	Transmission
<b>MERCEDES-BENZ</b> 	V30-3695	A 212 277 02 95 kit1	W205, W212, W222	7-speed / 7G-Tronic Plus Hybrid (724.2)
	V30-3696	A 725 270 15 18 kit1	W205, W213, W222	9-speed Hybrid (9G-Tronic 725.0)
	V30-3957	A 247 377 54 01 kit2	W177, W247, C118	8-speed DCT (724.1)
	V30-4427	A 725 270 31 14 kit1	9G-Tronic 725.0	9-speed (9G-Tronic, 725.0)
<b>MINI</b> 	V20-2091	24 11 7 518 741 kit2	Cabrio, Cooper, One	stepless (CVT16Z)
	V20-2094	24 34 7 566 358 kit2	R55, 56, 57, 58, 59, 60	6-speed (6F21WA - Aisin Warner TF60SN)
	V20-2095	24 34 7 551 087 kit2	Cooper S (R52)	6-speed (6F21WA - Aisin Warner TF60SN)
<b>NISSAN</b>	V38-0222	31728-3JX0B kit2	Cube, Juke, Versa Note	CVT (Jatco JF015)
	V38-0511	KE908-99932 kit1	Pathfinder, Qashqai	6-speed (Jatco JF613E, AJ0/AJ8)
<b>OPEL</b> 	V40-1604	07 03 304 kit2	Signum, Vectra C	5-speed (AF23 / AF33 / AW55-50)
	V40-1605	19 40 707 kit	Astra H+J, Insignia	6-speed (AF40, TF80,81)
	V40-2114	19 40 184 kit1	Astra J+K, Insignia	6-speed (6T45)
<b>PORSCHE</b> 	V45-0138	722 277 009 5 kit2	911 (996, 997)	5-speed - Tiptronic
	V45-0188	970 321 025 00 kit1	Panamera	Dual-clutch transmission (PDK)
	V45-0189	9G1 321 025 00 kit1	911	Dual-clutch transmission (PDK)
	V45-0269	9A7 317 189 00 kit2	Panamera (971)	Dual-clutch transmission (PDK) - ZF8D8T80
<b>RENAULT</b>	V46-1378	77 11 428 122 kit1	Clio, Megane	6-speed DSG® (DC4)
<b>ŠKODA</b>	V10-8037	09G 325 429 D kit2	Golf VII, Octavia, Yeti, Jetta IV	6-speed (09G, AQ160) Aisin Warner TF60SN
	V10-8038	09G 325 429 E kit2	Golf VII Leon, Polo	6-speed (09G, AQ160) Aisin Warner TF60SN
<b>SMART</b>	V30-4468	A 001 989 98 03 09 kit	Forfour 453	Reduction gearbox VA (790.997)
<b>TESLA</b> 	V58-0003	1618882-00-A kit1	Model 3, Model Y	Reduction gearbox VA
	V58-0004	1618882-00-A kit2	Model 3, Model Y	Reduction gearbox HA
<b>TOYOTA</b>	V70-0773	35330-60080 kit2	Land Cruiser, LX570	8-speed Aisin Warner

\* For detailed vehicle information, please refer to the vehicle lists under [www.vierol-shop.de](http://www.vierol-shop.de).

Notes: Temporary offers are only valid while stocks last. All offers remain subject to prior sale. Our general terms and conditions of sale and delivery as well as our warranty conditions apply, which are available for download on our web-site. All prices are net prices. Errors excepted. Reference numbers and names, with the exception of VIEROL AG, are for comparison only and may not be disclosed in invoices. They are non-binding and no indication of origin. © VIEROL AG

PRACTICAL. PROVEN. RELIABLE.

# ATF EXPERT GEAR PLUS

V99-1039

SIGHT GLASSES FOR EASY  
OIL CHANGE CONTROL

AUTOMATIC DETECTION  
OF OIL FLOW DIRECTION

OPTIONAL ADDITION  
OF CLEANING AGENTS

QUICK COUPLINGS  
FOR EFFORTLESS  
ADAPTER CHANGES

USER-FRIENDLY  
TOUCHSCREEN

2X 20 LITRES  
OIL TANKS

RUBBERISED SMOOTH-RUNNING ROLLERS

INCL. STANDARD 40-PIECE ADAPTER KIT

Powered by **VIEROL**



## ATF EXPERT GEAR PLUS

The user-friendly, intuitive navigation guides users step by step through the transmission flushing process and gives precise instructions based on the manufacturer's specifications. Oil changes and transmission flushing are performed conveniently and completely – with oil only and no additives.

- LCD touch display with user-friendly operation
- Multilingual printout
- Filling and recycling of automatic transmission oil
- Automatic electronic identification of the flow direction of the transmission oil
- Cyclical cleaning of the automatic transmission
- Easy filling of the flushing agent
- Automatic exchange of new/used oil
- Visual display of the oil pressure
- Oil temperature indicator
- Fully automatic exchange of new and used oil through intelligent electronic control
- Various special adapters for vehicle types from Europe, America and Asia

### TECHNICAL DATA

Service	Automatic, touchscreen	Oil pump	16 bar, 14 l/min
Oil filter	5 µ high-efficiency filter	Lines	2 x 2,5 m
Sight glasses	2 x visual inspection of oil quality	Power supply	220 - 240V/50 - 60Hz
Internal oil tanks	2 x 20 l	Load cells	2 x 50 kg
Language menu	11 different languages	Dimensions (H x W x D)	550 x 480 x 1130 mm
Service Report	via the unit's printer	Weight	70 kg

NEXT-LEVEL FLUSHING DEVICE WITH WEB CONNECTIVITY

# ATF EXPERT GEAR PRO

V99-0027

SIGHT GLASSES FOR EASY  
OIL CHANGE CONTROL

AUTOMATIC  
RECORDING  
OF OIL FLOW DIRECTION

OPTIONAL ADDITION  
OF CLEANING AGENTS

POWERFUL PUMP  
TO DRAIN THE TRANSMISSION

QUICK COUPLINGS  
FOR EFFORTLESS  
ADAPTER CHANGES

WIRELESS MONITORING  
VIA TABLET

CURRENT WEB DATABASE

2X 20 LITRES  
OIL TANKS

LARGE SMOOTH-RUNNING ROLLERS

INCL. EXTENSIVE ADAPTER KIT  
40-PIECE WITH, AMONG OTHERS, DSG®, 8HP AND  
POWERSHIFT ADAPTERS



## ATF EXPERT GEAR PRO

The winning formula for a complete transmission oil change is: transmission flushing. With the VAICO ATF EXPERT GEAR Pro, we offer a fully automatic flushing unit that leaves nothing to be desired:

- Wireless control and monitoring via tablet
- User-friendly operation and integrated web database
- Fully automatic maintenance sequences and graphic instructions
- Automatic fill level and oil level monitoring
- Automatic identification of the flow direction of the transmission oil
- Cyclical cleaning of the automatic transmission
- Creation & printing of maintenance reports
- Visual display of the oil pressure
- Oil temperature indicator
- Fully automatic exchange of new and used oil through intelligent electronic control
- An extensive set of special adapters is already included in the standard 40-piece scope of delivery

### TECHNICAL DATA

Service	Automatic, 10.1" tablet	Oil pump	16 bar, 14 l/min
Oil filter	10 µ high-efficiency filter	Lines	2 x 2.5 m
Sight glasses	2 x visual inspection of oil quality	Power supply	230 V, 50 Hz
Internal oil tanks	2 x 20 l	Load cells	2 x 50 kg
Language menu	12 different languages	Dimensions (H x W x D)	550 x 480 x 1130 mm
Service Report	To printer via Wi-Fi	Weight	60 kg



All articles from  
this brochure on  
[www.vierol-shop.de](http://www.vierol-shop.de)



# ALL ASSORTMENTS ON [WWW.VIEROL-SHOP.DE](http://WWW.VIEROL-SHOP.DE)



## WE ARE ALWAYS THERE FOR YOU!

**VIEROL AG**  
Karlstraße 19  
26123 Oldenburg  
Germany

Tel.: +49 (0) 441 - 210 20 - 0  
Fax: +49 (0) 441 - 210 20 - 509  
E-Mail: [info@vierol.de](mailto:info@vierol.de)

Dealer stamp

